



# SIKA MARINE APPLICATION GUIDE

## STRUCTURAL BONDING MARINE APPLICATIONS

Version 2/2017

# CONTENT

**03** Sika Solutions for Structural Bonding

---

**05** Direct Glazing

---

**08** Bonding and Sealing Organic Windows

---

**11** Bonding and Sealing Mineral Glazing

---

**14** Flybridge Bonding

---

**16** Deck to Hull Bonding

---

**18** Keel to Hull Bonding



# SIKA SOLUTIONS FOR STRUCTURAL BONDING

## MATERIALS AND TECHNOLOGIES

The main property of elastic bonding adhesives is that they are capable to support high mechanical stresses.

This single detail gives rise to concerns regarding the finished vessel in service, where, despite the improved assembly benefits, there can still be localised stress issues and a greater possibility of joint fracture due to impact or crushing forces.

Following extensive research, Sika has found that by introducing a degree of flexibility, these problems are greatly improved.

The Sikaflex® elastic adhesives for structural bonding are:

- Sikaflex®-292i
- Sikaflex®-296
- Sikaflex®-295 UV

Sikaflex®-292i is used to bond flybridges and keels as each of these can be subject to far greater local forces than other main components. The greater flexibility in these cases means that there will be greater 'give' in the first instance. The members would be more likely to be pulled off the vessel whole, without ripping pieces from the hull or superstructure. This also means that there is every chance that the components can be refitted without needing to be replaced.

Sikaflex®-295 UV and -296 are each used for glazing, as windows are increasingly used as structural members. Sikaflex®-295 UV is used for organic glazing and backfilling and Sikaflex®-296 is used for mineral glazing. In both cases the greater flexibility is to prevent forces being transmitted to the glazing that would otherwise damage it.

The following examples show the capability of the Sikaflex® Marine adhesives. However the custom tailored characteristics gives naval engineers and constructors the possibility of economic and sustainable new realisations. Sika will be happy to support you in the development and testing of new applications.

		MECHANICAL FIXING	LAMINATING TAPING	ELASTIC BONDING
MANUFACTURING	Time consumption	●	●	○
	Material cost	●	●	●
	Process complexity	● / ●	●	●
	Health / safety / environment	● / ○	●	●
	Tolerance gapping	●	●	●
	Assembling different (lightweight) materials	●	●	●
FINAL PERFORMANCE	Durability / fatigue resistance	○	●	●
	Durability / corrosion resistance	●	●	●
	Weight reduction	●	●	●
	Comfort (acoustics)	●	●	●

● Very good   ● Good   ○ Neutral   ● Poor   ● Very poor





## DIRECT GLAZING

### DESCRIPTION

Traditional glazing methods have evolved as they had due to the limitations in the performance of the glass. A sturdy window frame was required to hold the glass in place and to protect it from forces that would shatter it. Also, the size of a window was limited for similar reasons and a broken window in heavy weather could compromise the safety of the vessel.

In addition marine regulations define the areas on the ship where bonding of windows is allowed and where additional mechanical fixations are necessary. It is therefore of interest to contact a Classification Society in case of vessels which are submitted to IMO and SOLAS or other national rules.

Modern glazing can be realised with mineral and organic glasses. The manu-

facturing techniques allow windows of superlative performance to be produced in almost any shape, size and curvature to give designers the possibility of modern realisation of ships.

The traditional role of glazing as protection against the elements whilst allowing light and vision to pass through, has been extended to include the extra benefit of structural member.

Direct glazing, using peripherally applied structural adhesive systems, has become the primary method of installing windows due to the extensive list of benefits:

- Better protection against the elements than framed windows.
- Significantly improved design and styling capabilities for the marine architect by elimination of trim, frame and screws.
- Enlarged window area permits a more imaginative styling.
- Lower weight reduces running costs and improves speed.
- Fewer materials required reduce the cost of the build with lower component cost and quicker assembly times.
- Improved torsion stiffness of the boat.
- Reduction of the natural frequencies and vibrations, leading to an improved ride comfort.
- Improved aerodynamics reducing wind noise in operation.
- Better bridging of tolerances which has the advantages of quicker assembly and reduced adjustment costs.
- Greatly reduced production times leading to quicker delivery and lower labour costs.
- Fewer glass breakages both during construction and in operation.
- Easy repair at any place due to Sika's global presence.

## DESIGN DIRECTIVES

Direct glazing represents a straight-forward process whereby the glass is bonded directly to the body of the vessel. This must comply with all industry standards as laid down by the governing bodies, such as the classification societies, in each respective country. Specific details are described as appropriate for mineral and organic glazing later in this manual, but the general criteria are described following.

## UV PROTECTION

The bond line material must be protected from direct UV radiation as this causes deterioration of the chemical composition leading to failure. This is normally carried out by including a light impermeable mask as part of the design of the window. This can appear in the form of:

- Ceramic coating (peripheral) for mineral glass
- UV impervious paint or ink for organic glass
- External trim

The black silk screened ceramic border around the edge of the window is often feathered towards the centre of the window using various dot densities, resulting in an attractive shading effect. Adhesives can also be protected using external trim that is large enough to keep out the ultraviolet light and is also attractively designed such to enhance the appearance of the finish.

See page 9 for organic glass and page 12 for mineral glass for dimensioning the adhesive layer.

## FITTING DIMENSIONS

Not only does the window have to fit correctly into the allotted aperture during assembly, but it must also take into account the changes that occur to the superstructure and the window under operating conditions.

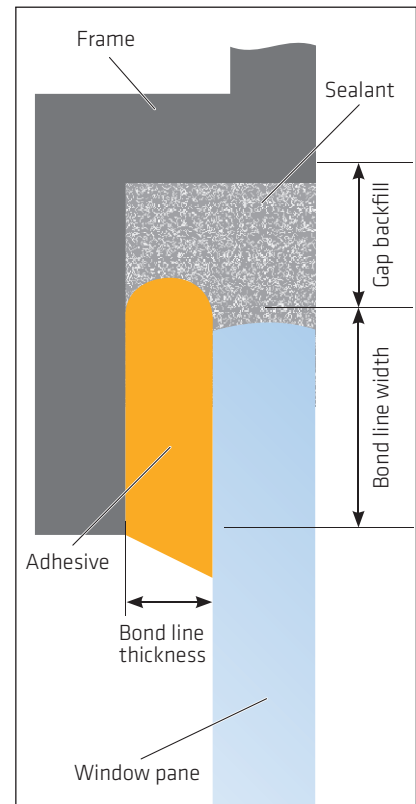

Fig. 2 Bonding a decorative panel vertically

### BOND LINE WIDTH

The overlapping area between the frame and the glazing, known as the bond line width, should be large enough to allow sufficient adhesive to bear the weight of the glazing, as well as the suction load and head pressure to which the environment exposes it. A dimensioning guide is provided adjacent to the different procedures for mineral and organic windows.

### BOND LINE THICKNESS

After it has set, the adhesive remains flexible. However, if too thinly applied, the adhesive may shear due to the changes in dimension caused by differences in thermal coefficient of expansion between the glazing and the superstructure and also the natural flexing between the glazing and the window frame in the varying sea conditions. Sika's dimensioning guide provided adjacent to the appropriate procedures determines the depth of spacers required to be placed within the adhesive to keep the distance equal to or greater than the minimum depth required to ensure the reliability and longevity of the adhesive and the bond.

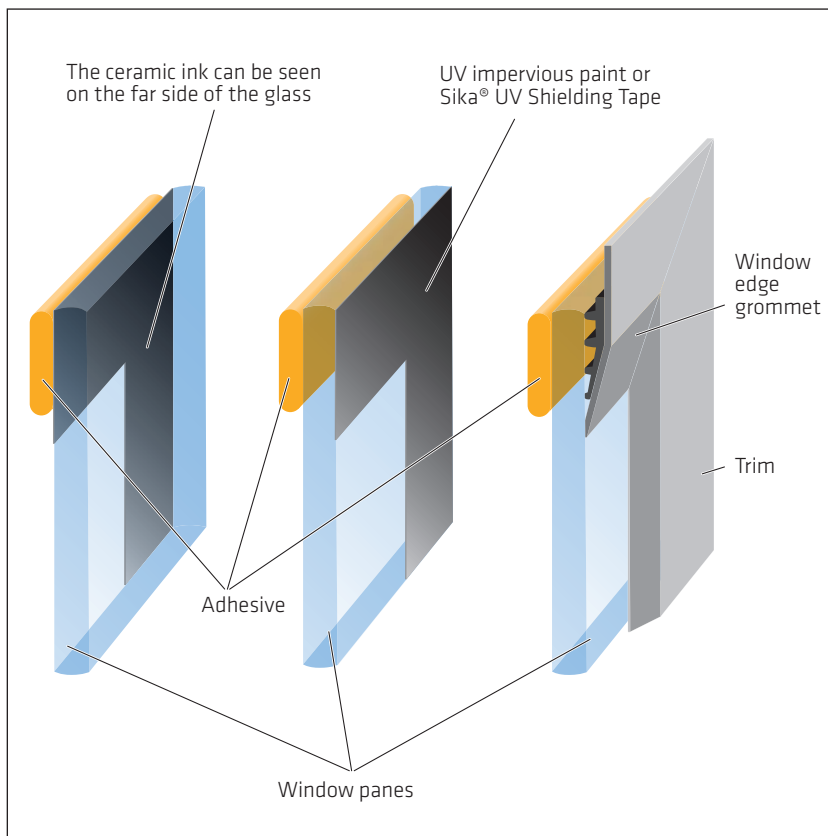

Fig. 1 Bonding a decorative panel vertically

### GAP BACKFILLING

Around the edge of the glazing, there should be a gap sufficient to prevent contact between the glazing and the window frame for all temperatures and under all mechanical strains. A dimensioning guide is provided adjacent to the appropriate procedures.

### SURFACE PREPARATION

The adhesion properties between the glazing and the window mounting material must be verified by Sika's Technical Department to ensure that the correct materials, solutions and methods are used and followed. Procedure for organic and for mineral glass are described on the following pages. Improperly prepared surfaces could result in failure of the bond and may put the safety of the vessel in jeopardy.

The high quality of Sika products is guaranteed and whereas Sika cannot vouch for the quality or compatibility of other manufacturer's products, only Sika primers, cleaners and adhesion promoters should be used with Sika adhesives and sealants.

### PRIMERS AND CLEANERS

Flash off times for cleaners and primers must be strictly observed.

### PRODUCT SELECTION FOR BOTH MINERAL AND ORGANIC WINDOWS

Selection of the correct surface preparation system is of utmost importance; as is the selection of the correct adhesive. These both depend on the type of window to be installed. The following table shows which adhesive should be used:

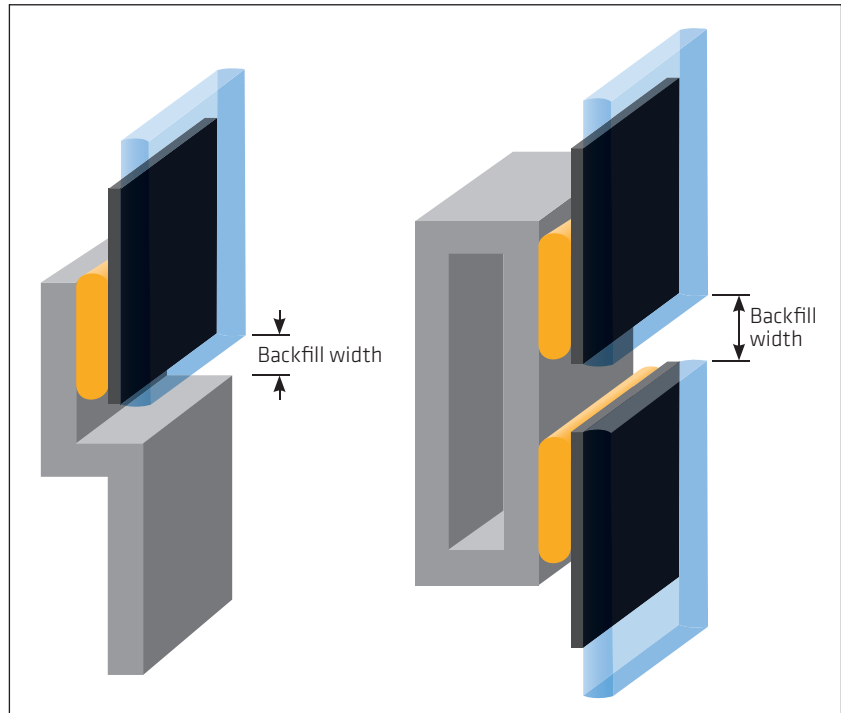

Fig. 3 The definition of backfill width

	BONDING	SEALING / BACKFILL
MINERAL GLAZING (SINGLE GLAZING)	Sikaflex®-296	Sikaflex®-296
MINERAL GLAZING (DOUBLE GLAZING)	Sikaflex®-296	Sikasil® WS-605 S
ORGANIC GLAZING	Sikaflex®-295 UV	Sikaflex®-295 UV
MINERAL GLAZING (INSULATING)	Sikaflex®-296	Sikaflex®-605 S
MINERAL GLAZING (LAMINATING)	Sikaflex®-296	Sikaflex®-296





## BONDING AND SEALING ORGANIC WINDOWS

### APPLICATION DESCRIPTION

Most of the organic glazing materials used in boat building are clear acrylic sheet (PMMA).

Plastic glazing products have a high coefficient of thermal expansion. In general, incorrectly installed plastic glazing panels are prone to environmental stress cracking (ESC). This can be aggravated by the use of the wrong adhesives or wrong dimensioned adhesive / sealant.

Plastic glazing products have a higher coefficient of thermal expansion than conventional glass.

Therefore, when designing glazing installations, an expansion gap of at least 8 mm all round the periphery must be incorporated between the window rebate and the plastic glazing panel to accommodate thermal movement. In case of additional mechanical fixations any clearance holes for fixing screws must be drilled oversize; slightly larger than the diameter of the screw shank. See also plastic manufacturer recommendations.

To minimise the risk of environmental stress cracking, flat sheets of plastic glazing material should be installed completely flat; they should not be forced to take up a curvature by the use of mechanical fastenings.

When the design calls for curved glazing panels, these should be prefabricated to order and properly tempered by a specialist supplier to ensure installation with no remaining stresses.

As many varieties of organic window exist, it is recommended to ensure that the specific grade selected is suitable for use with Sikaflex®-295 UV. Please note that the extruded type of organic glazing (XT) exhibits a higher tendency to environmental stress cracking than the cast type (GS).

Please contact your local Sika company for technical advice.



## PROCEDURE FOR BONDING AND SEALING WITH Sikaflex®-295 UV ORGANIC WINDOWS

### BONDLINE CONFIGURATION

Organic windows have a high thermal movement which creates stress in the bond line. Additionally dynamic stress due to the boat movement and the wind load have to be taken in consideration.

The following graphs are a result of theoretical and practical experience, considering all parameters of a boat under the conditions to which a window is subjected.

Basis of calculation are substrates MMA/GFK, wind load 2 kN/m<sup>2</sup>, ΔT = 30° C

### ADHESIVE WIDTH (BITE)

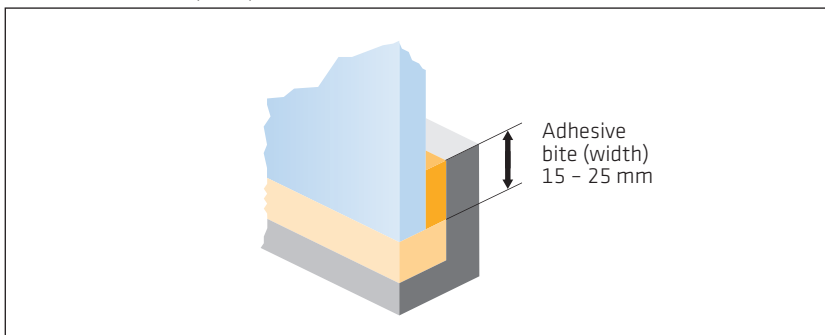

### JOINT THICKNESS

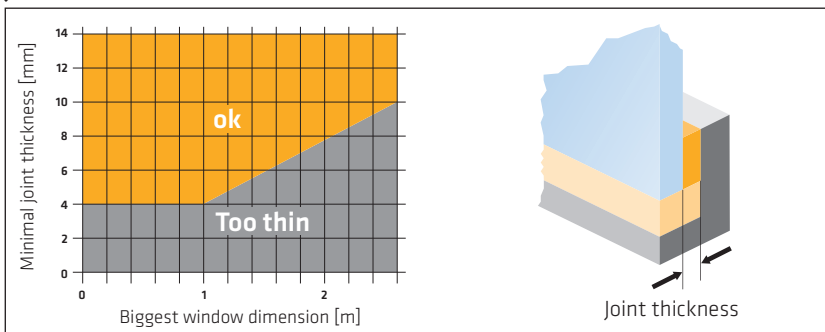

### JOINT WIDTH

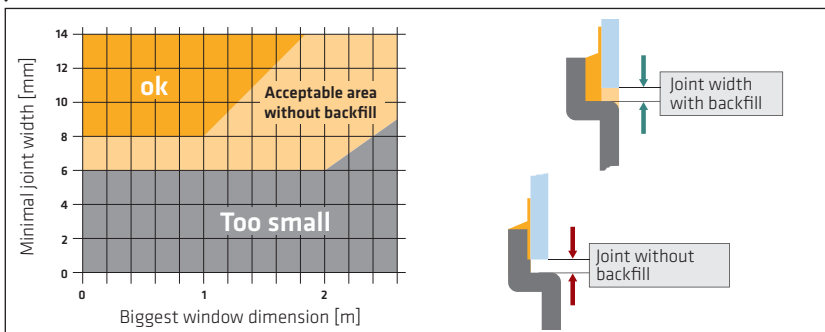

Note: For important projects consult Corporate Technical Service Sika Industry

## SUBSTRATE PREPARATION

### GRP FRAME

	Lightly abrade the gel coat of the contact area with a very fine sanding pad
	Remove the dust with a vacuum cleaner
	Mask off any areas that need it
 SA 205	Pre-treat the substrate with Sika® Aktivator-205, using a clean, lint-free rag or paper towel. Change the rag frequently!
	Flash-off: 10 minutes (min) to 2 hours (max)
 SMM	Apply a thin, continuous coat of Sika® MultiPrimer Marine, using a clean brush or felt applicator
	Drying time: 30 minutes (min) to 24 hours (max)

### ALUMINUM FRAME

	Mask off any areas that need it
	Lightly abrade the contact area with a fine sand pad
	Remove the dust with a vacuum cleaner
 SA 205	Pre-treat with Sika® Aktivator-205, using a clean, lint-free rag or paper towel. Change the rag frequently!
	Flash-off: 10 minutes (min) to 2 hours (max)
 SMM	Apply a thin, continuous coat of Sika® MultiPrimer Marine, using a clean brush or felt applicator
	Drying time: 30 minutes (min) to 24 hours (max)

### ALUMINUM OR TIMBER FRAME COATED WITH TWO-PART LACQUER

	Mask off any areas that need it
 SA 100	Pre-treat the substrate with Sika® Aktivator-100, using a clean, lint-free rag or paper towel. Change the rag frequently!
	Flash-off: 10 minutes (min) to 2 hours (max)



**IMPORTANT:**  
For the preparation of other substrates, please refer to the Pre-Treatment Chart for Sika Marine Applications or contact the local Technical Service Sika Industry

### PMMA / PC GLAZING PANELS



ACRYL PAINT

If required, apply an acryl paint or a profile opaque to cover the bond line in accordance with the Sika recommendations.



Abrade the bond area with abrasive paper or very fine abrasive pad. Abrade the bonding periphery with 80 grit sand-paper if the organic glazing panel has a scratch proof coating (example Margard)



Remove the dust with a vacuum cleaner



Mask off any areas that need it



209 D

Apply a continuous coat of Sika® Primer-209 D, using a clean brush or felt applicator



Drying time: 30 minutes (min) to 24 hours (max)

### BOND LINE PROTECTION

As with conventional glass, plastic glazing panels generally do not protect the adhesive face from damage by UV radiation. Therefore, the bond line must be protected from direct sunlight using one of the methods recommended.

- External cover strip of appropriate dimensions
- Internal sieve printing acrylic paint (contact Technical Service Sika Industry for appropriated types)

The use of black Primer Sika® Primer-209 D as a sole UV-protection is only permitted in case of a low UV-transmission of the organic glass (UV-transmission < 0,5% )

### APPLICATION OF Sikaflex®-295 UV ADHESIVE



Place spacers in position. Depending on the size of the glazing panel, the thickness of the spacer should be chosen accordingly (see page 2). Shore A hardness of the spacer approximately 30 or less



Avoid interruption of the bead by the spacers



295 UV

Apply Sikaflex®-295 UV to the frame rebate or glazing panel using a triangular nozzle with a bead width of at least 10 mm



Assemble all components within 20 minutes of applying the adhesive



To prevent slip down of vertical glazing panels, distance blocks (wood or plastic) must be placed in the lower rebate during installation. After curing, these must be removed. The backfill gap must be at least 8 mm (see page 2)



Fastening aids can be removed after 24 hours. After this time, the expansion gap between glazing panel and the backfill gap should be filled and completely sealed with Sikaflex®-295 UV. This sealant joint can be tooled to a smooth finish using Sika® Tooling Agent N. This must be carried out before skinning of the sealant



295 UV



Tooling



After tooling remove any masking tape before the adhesive skins over



208

Uncured Sika adhesives or sealants may be removed with Sika® Remover-208

### WINDOW EDGE SEALING/ BACKFILLING

Commonly, the edge of the window will be cosmetically finished with Sikaflex®-295 UV. The preparation of the surfaces must be identical to that used for bonding. Edge sealing ensures both the prevention of standing water on or near the bond and helps cosmetically finish the window. Fill up the joint completely, ensuring there is no space between the adhesive bead and the joint. The diagram on page 9 illustrates the required dimensioning of the back-fill gap for plastic window panels using Sikaflex®-295 UV.



**IMPORTANT:**  
Always refer to the current Sika Product Datasheet and Safety Datasheet obtainable through your local Sika company

### SIKA RULE

$$O = 2 \times D$$

#### Example:

If  $D = 8 \text{ mm}$ , the overlap should be at least  $16 \text{ mm}$

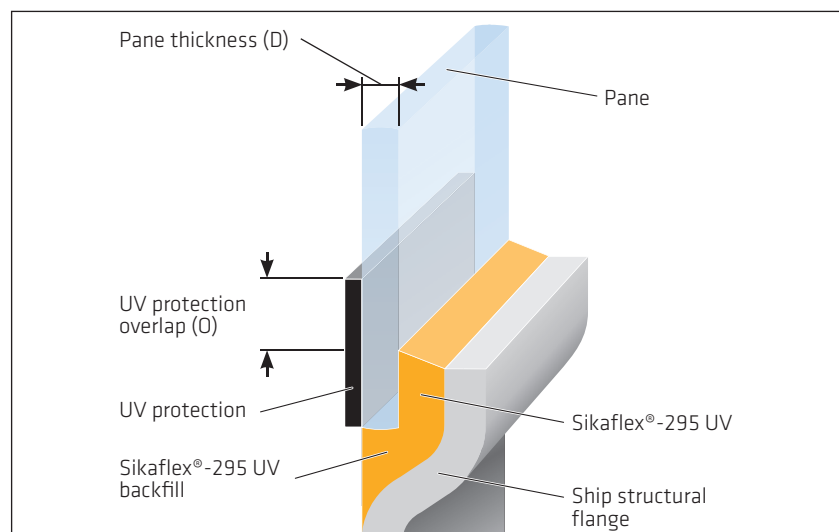

Fig. 4 Bonding a decorative panel vertically



## BONDING AND SEALING MINERAL GLAZING

### APPLICATION DESCRIPTION

The direct mineral glazing into frames or directly into the hull or deck, requires a full understanding of all the important principles involved.

It is essential that the glass meets all the demands and standards required for the intended application, such as IMO resolutions or other regulations as laid down by the classification societies.

In case of self cleaning glass we ask you to consult the Corporate Technical Service Sika Industry.

The adhesive bond line must be protected against UV radiation.

This may be achieved using several materials and methods:

- Using a black, ceramic coated border with a light transmission of less than 0.01%.



#### IMPORTANT:

Local and international rules for maritime constructions and appropriate legislation must always be observed.

## BONDING AND SEALING MINERAL GLASS WITH Sikaflex®-296

### ADHESIVE AND SEALANT DIMENSIONING

The dimensioning of the adhesive and the joint geometry must be carried out in accordance with Sika's basic rules of calculation. If deck movement is negligible the following dimensions are recommended.

**IMPORTANT:**  
At all times recommendations from classification societies must be respected

Basis of calculation substrate aluminum-glass, wind load 2,4 kN/m<sup>2</sup>, ΔT = 40° C

### DETERMINATION OF THE ADHESIVE WIDTH (BITE)

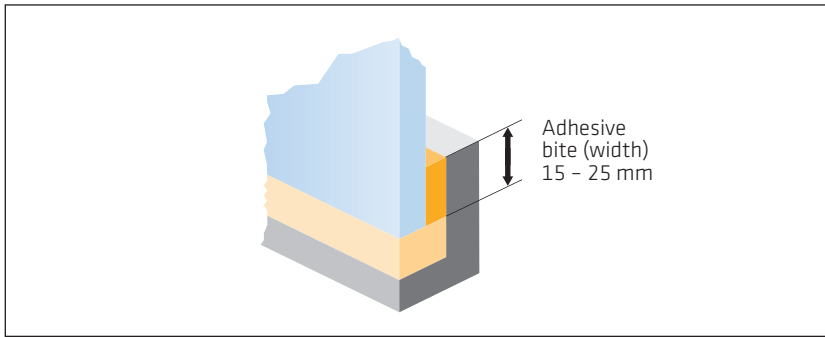

### ADHESIVE THICKNESS

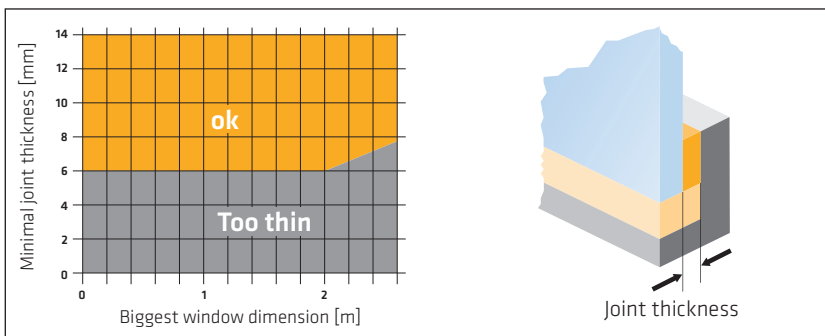

### JOINT WIDTH

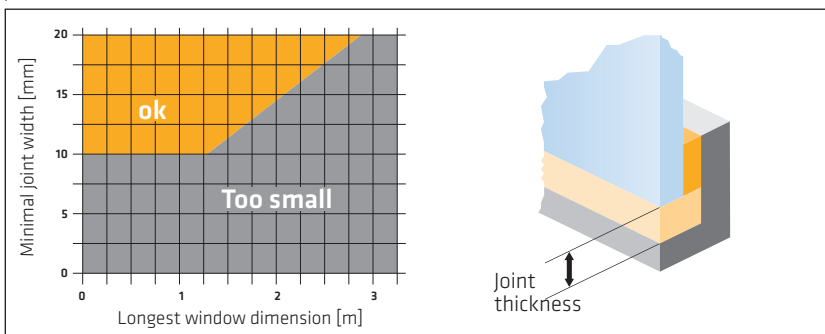

Note: For insulating glass or important projects consult Corporate Technical Service

### SUBSTRATE PREPARATION

#### GRP FRAME

	Lightly abrade the gel coat of the contact area with a very fine sanding pad
	Remove the dust with a vacuum cleaner
	Mask off any areas that need it
 SA 205	Pre-treat the substrate with Sika® Aktivator-205, using a clean, lint-free rag or paper towel. Change the rag frequently!
	Flash-off: 10 minutes (min) to 2 hours (max)
 SMM	Apply a thin, continuous coat of Sika® MultiPrimer Marine, using a clean brush or felt applicator
	Drying time: 30 minutes (min) to 24 hours (max)

For the preparation of other types of frames, please refer for the Pre-Treatment Chart for marine application.





#### GLASS WITH EXTERNAL UV PROTECTION OR WITH BLACK CERAMIC BORDER (TRANSMISSION < 0.01%)





 SA 100	Pre-treat the substrate with Sika® Aktivator-100, using a clean, lint-free rag or paper towel. Change the rag frequently!
	Flash-off: 10 minutes (min) to 2 hours (max)

#### GLASS WITH BLACK CERAMIC GLASS BORDER (TRANSMISSION > 0.01% VISIBLE LIGHT)

 SA 100	Pre-treat the substrate with Sika® Aktivator-100, using a clean, lint-free rag or paper towel. Change the rag frequently!
	Flash-off: 10 minutes (min) to 2 hours (max)
 206 G+P	Apply a thin, continuous coat of Sika® Primer-206 G+P, using a clean brush or felt applicator
	Drying time: 30 minutes (min) to 24 hours (max)

## APPLICATION OF Sikaflex®-296 ADHESIVE

	Place spacers in position. Depending on the size of the glazing panel, the thickness of the spacer should be chosen accordingly. Shore A hardness of the spacer approximately 40 or less
	Avoid interruption of the bead by the spacers
 296	Apply Sikaflex®-296 to the frame rebate or glazing panel using a triangular nozzle with a bead width of at least 10 mm
	Assemble all components within 20 minutes of applying the adhesive

	To prevent slip down of vertical glazing panels, distance blocks (wood or plastic) must be placed in the lower rebate during installation. After curing, these must be removed. The rebate gap must be at least 10 mm (see page 2)
	Clamps and other fastening aids can be removed after 24 hours.
 296	After this time, the expansion gap between glazing panel and the rebate should be filled and sealed with Sikaflex®-296. This sealant joint can be tooled to a smooth finish using Sika® Tooling Agent N.
 Tooling	This must be carried out before skinning of the sealant



	After tooling remove any masking tape before the adhesive skins over
 208	Uncured Sika adhesives or sealants can be removed with Sika® Remover-208



Fig. 5 Pre-treatment of the ceramic ink area with Sika® Aktivator-100



Fig. 6 Adhesive is applied to the window frame



Fig. 7 The window is fitted



## FLYBRIDGE BONDING

### APPLICATION DESCRIPTION

Many modern motor yachts have flybridges. Conventional fixing methods such as mechanical fixings or rigid adhesives have concentrations of peak stresses which lead to breaching of the substrate allowing access to moisture.

Bonding of flybridges using flexible adhesive systems evens the distribution of stresses and optimises resistance to impact and fatigue effects.

In service, flybridges are subjected to substantial stress on the joints at high speeds. The main reason that makes Sikaflex®-292i perfect for this application is the high modulus characteristic that ensure the integrity of the joint under stress.

A perfect cosmetic finish is obtained with the weather resistance Sikaflex®-295 UV in white colour.

## FLYBRIDGE BONDING PROCEDURE

### PREPARING THE SUBSTRATE GRP















 208	Heavily soiled surfaces should first be cleaned off with a pure solvent, like Sika® Remover-208, to remove the worst of the soiling
	Lightly abrade the contact area with a very fine sanding pad
	Remove the dust with a vacuum cleaner
 SA 205	Pre-treat the substrate with Sika® Aktivator-205, using a clean, lint-free rag or a paper towel. Change the rag frequently!
	Flash-off: 10 minutes (min) to 2 hours (max)
 SMM	Apply a thin, continuous coat of Sika® MultiPrimer Marine, using a clean brush or a felt applicator
	Drying time: 30 minutes (min) to 24 hours (max)



Fig. 8 Sealing with Sikaflex®-295 UV

### APPLICATION OF Sikaflex®-292i ADHESIVE

	Place 3 mm deep elastic spacers, of about 50 Shore A hardness, into position
 292i	Apply Sikaflex®-292i in an appropriate profile around the entire periphery of the flybridge. An additional bead may be required for heavier loads
	Assemble the components within 20 minutes of applying adhesive
	Apply pressure with clamps or other fastening aids to compress the adhesive to the height of the spacers

 208	Uncured Sika adhesives or sealants should be removed with Sika® Remover-208
 295 UV	For open joints, cover Sikaflex®-292i with a layer of Sikaflex®-295 UV
	Clamps and other fastening aids can be removed after 12 hours. Full service strength is attained after about 7 days

**IMPORTANT:**  
Always refer to the current Sika Product Datasheet and Safety Datasheet obtainable through your local Sika company





## DECK AND KEEL TO HULL BONDING

### APPLICATION DESCRIPTION

Arguably the most crucial joint on the vessel is that between the deck and the hull where Sika's resilient, one-component polyurethane adhesives have many benefits to the designer and boat builder alike.

The naval architect can be confident that a deck and a hull that have been built separately of differing materials can be brought together to form a single unit that is both strong and durable. The tolerances in alignment between the two parts need not be quite as close, because minor discrepancies can be taken up by the gap filling property of the adhesives.

The strength of the adhesives makes mechanical fixings redundant and the resilience absorbs much of the stresses and strains from temperature changes, impact shocks and torsion forces.

All of these factors reduce the design and source costs of the build and remove many design obstacles.

To the boat builder, the assembly techniques are simplified and streamlined.

Applying an adhesive around the joint between deck and hull is far quicker, simpler and easier than laborious GRP laminated joints.

And providing the Sika guidelines are followed ensures a reliable watertight joint, as is not the case with taping methods.

With no mechanical fixings, there is no need to drill holes in the joint area, no need for gaskets, no need to spend the time aligning the holes and no need to insert and tighten the fixings.

For information regarding bondline dimensions, please contact Sika's Technical Service department, who can also provide appropriate values for FEM calculations.







Also, the critical joint between keel and hull is subjected to very high stresses when a boat is under sail and needs to be very strong if it runs aground. So it must be designed and built with great care in order to withstand these stresses.

This particular joint is prone to leaks, which identify themselves by rust streaking and staining on the keel when the boat is out of the water.









## DECK TO HULL BONDING PROCEDURES WITH Sikaflex®-292i

### PREPARING THE SUBSTRATE FOR ALUMINUM

 208	Heavily soiled surfaces should first be cleaned off with a pure solvent, like Sika® Remover-208, to remove the worst of the soiling
	Lightly abrade the contact area with a very fine sanding pad
	Remove the dust with a vacuum cleaner
 SA 205	Pre-treat the substrate with Sika® Aktivator-205, using a clean, lint-free rag or a paper towel. Change the rag frequently!
	Flash-off: 10 minutes (min) to 2 hours (max)
 SMM	Apply a thin, continuous coat of Sika® MultiPrimer Marine, using a clean brush or a felt applicator
	Drying time: 30 minutes (min) to 24 hours (max)

### PREPARING THE SUBSTRATE FOR GRP

 208	Heavily soiled surfaces should first be cleaned off with Sika® Remover-208, to remove the worst of the soiling
	Lightly abrade the contact area with a very fine sanding pad
	Remove the dust with a vacuum cleaner
 SA 205	Pre-treat the substrate with Sika® Aktivator-205, using a clean, lint-free rag or a paper towel. Change the rag frequently!
	Flash-off: 10 minutes (min) to 2 hours (max)
 SMM	Apply a thin, continuous coat of Sika® MultiPrimer Marine, using a clean brush or a felt applicator
	Drying time: 30 minutes (min) to 24 hours (max)

### OTHER SUBSTRATE

Refer to the actual Sika Pre-Treatment Chart for Marine Applications.

### APPLICATION OF Sikaflex®-292i

**IMPORTANT:**  
It is vital to check the accuracy of the fit before applying the adhesive so that the parts do not need to be separated again once they have been brought together

 Place spacers of at least 4 mm deep and about 50 shore A hardness, in position. Alternatively, these can be pressed into the adhesive once applied

  
292i Apply Sikaflex®-292i onto the entire periphery of the hull. A continuous zig-zag bead Sikaflex®-292i should be used (Fig. 9 and 10); the amount applied will depend on the width of the bond face. The adhesive bead must be carried continuously around any cut-outs or clearance holes (e.g. for deck stanchions, pipes, chain plates) to maintain the integrity of the watertight joint

 Assemble the components within 20 minutes of applying the adhesive

 Apply pressure with clamps or other fastening aids to compress the adhesive to the height of the spacers

 Clamps and other fastening aids can be removed after 24 hours. Full service strength is attained after approximately 7 days

  
208 Uncured Sika® adhesives or sealants must be removed with Sika® Remover-208

**IMPORTANT:**  
Do not use Sika® Aktivator or any other cleaning agent or solvent for cleaning purposes

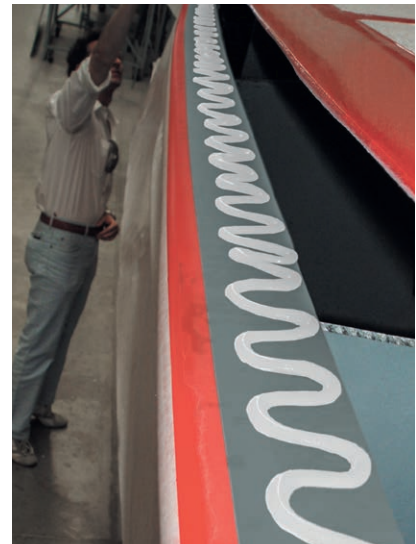

Fig. 9 Hull and deck are brought together

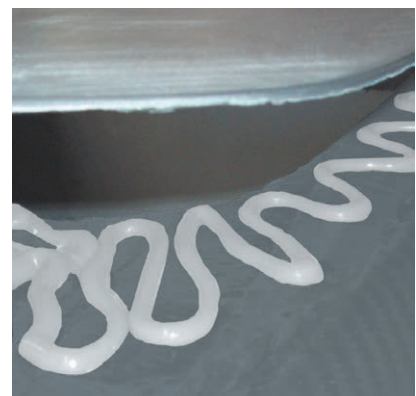





Fig. 10 A locating pin ensures perfect alignment







## KEEL TO HULL BONDING

### SUBSTRATE PREPARATION

#### ALUMINUM HULLS (PAINTED WITH 2C PAINT)

 208	Heavily soiled surfaces should first be cleaned off with Sika® Remover-208, to remove the worst of the soiling
 SA 100	Pre-treat the substrate with Sika® Aktivator-100, using a clean, lint-free rag or a paper towel. Change the rag frequently!
	Flash-off: 10 minutes (min) to 2 hours (max)

#### GRP HULLS

 208	Heavily soiled surfaces should first be cleaned off with Sika® Remover-208, to remove the worst of the soiling
	Lightly abrade the contact area with a very fine sanding pad
	Remove the dust with a vacuum cleaner
 SA 205	Pre-treat the substrate with Sika® Aktivator-205, using a clean, lint-free rag or a paper towel. Change the rag frequently!
	Flash-off: 10 minutes (min) to 2 hours (max)
 SMM	Apply a thin, continuous coat of Sika® MultiPrimer Marine, using a clean brush or a felt applicator
	Drying time: 30 minutes (min) to 24 hours (max)

#### STEEL HULLS AND KEELS, COATED WITH TWO-PART CORROSION PROTECTION PAINTS

**IMPORTANT:** One-component paints are not suitable to be bonded on it. To control the quality of the paint we recommend cleaning a small part with paint thinner. If the paint resists to the solvent it is suitable and can be bonded as described in the following part. In case of the paint can be dissolved, it has to be removed and replaced by a two-component epoxy paint



 SA 100	Pre-treat the substrate with Sika® Aktivator-100, using a clean, lint-free rag or a paper towel. Change the rag frequently!
	Flash-off: 10 minutes (min) to 2 hours (max)



Fig. 11 A keel is carefully slid into position



Fig. 12 The adhesive is applied





**IMPORTANT:** With lead keels, the contact area must also be given a coating with a two-part epoxy-resin based protective paint

For the preparation of other substrates, please refer to the Pre-Treatment Chart for Sika Marine Applications.



Fig. 13 The joint is tooled off and finished

### APPLICATION OF Sikaflex®-292i ADHESIVE

	Place elastic spacers of about 10 mm thick and 50 Shore A hardness into position
 292i	Apply Sikaflex®-292i in sufficient quantity. Each bead must form a continuous, closed ring, with no gaps. The same applies to the beads around the bolt holes
	The keel must then be lifted into position, carefully observing the open time of Sikaflex®-292i. Then the keel bolts must be tightened as far as the spacer blocks. Any adhesive that is squeezed out of the joint can be tooled to a finish
 208	Remove Sika adhesives or sealants with Sika® Remover-208
	After three or four days, the keel bolts can be tightened to their full torque rating. The additional pressure exerted on the adhesive, gives the joint between keel and hull the required degree of torsional stiffness. When the adhesive has fully hardened, the sealed joint can be over-painted in the normal way with any good quality anti-fouling paint. The sealed joint absorbs the dynamic stresses generated in this area and forms a totally water-tight bond between keel and hull

#### DISCLAIMER

The information, and, in particular, the recommendations relating to the application and end-use of Sika products, are given in good faith based on Sika's current knowledge and experience of the products when properly stored, handled and applied under normal conditions. In practice, the differences in materials, substrates and actual site conditions are such that no warranty in respect of merchantability or of fitness for a particular purpose, nor any liability arising out of any legal relationship whatsoever, can be inferred either from this information, or from any written recommendations, or from any other advice offered.

The proprietary rights of third parties must be observed. All orders are accepted subject to our current terms of sale and delivery. Users should always refer to the most recent issue of the Sika Product Datasheet for the product concerned, copies of which will be supplied on request.

# GLOBAL BUT LOCAL PARTNERSHIP



## FOR MORE MARINE INFORMATION:



[www.sika.com/marine](http://www.sika.com/marine)

### Who we are

Sika is a specialty chemicals company with a leading position in the development and production of systems and products for bonding, sealing, damping, reinforcing and protecting in the building sector and the motor vehicle industry. Sika has subsidiaries in 94 countries around the world and manufactures in over 170 factories. Its more than 17,000 employees generated annual sales of CHF 5.49 billion in 2015.

Our most current General Sales Conditions shall apply.  
Please consult the Data Sheet prior to any use and processing.



**Sika Services AG**  
Tueffenwies 16  
8048 Zurich  
Switzerland

**Contact:**  
Phone: +41 58 436 40 40  
Fax: +41 58 436 45 30  
[www.sika.com/marine](http://www.sika.com/marine)

**BUILDING TRUST**

